

KEY FEATURES

- Designed for compression drivers with 2" mouth diameter
- It provides uniform response, on and off-axis with a neutral and natural frequency reproduction
- Coverage angles of 60° in the horizontal plane and 40° in the vertical plane
- Made of synthetic resin, with an aluminium coupler
- Precise directivity control in the pass band.



GENERAL DESCRIPTION

This 2" entry horn is designed to provide uniform on and off-axis response. The constant directivity characteristics of this model ensure the ability to cover 60° wide horizontally and 40° wide vertically, at virtually any frequency within its operational range. To ensure freedom of resonance, this flare is constructed of heavy-duty resin, and aluminium adapter for precise pattern control.

TECHNICAL SPECIFICATIONS

Throat diameter	49 mm. 2 in.
Horizontal beamwidth	60° (+31° -9°) (-6dB, 0.63 - 16 kHz)
Vertical beamwidth	40° (+17° -10°) (-6dB, 1.6 - 16 kHz)
Directivity factor (Q)	16.8 (average 0.63 -16 kHz)
Directivity index (DI)	12.3 dB (+1.8 dB, -4.3 dB)
Cutoff frequency	800 Hz
Dimensions	WxHxD: 250 x 280 x 220 mm.
Cutout dimensions	WxH: 215 x 245 mm.
Net weight	2.5 kg.
Shipping weight	3.3 kg.

Construction
Synthetic resin. Aluminium adaptor.
Connection of driver by four screws on a 4 in. (101.6 mm.) diameter bolt circle. Mounting hardware is supplied.

DIMENSION DRAWINGS

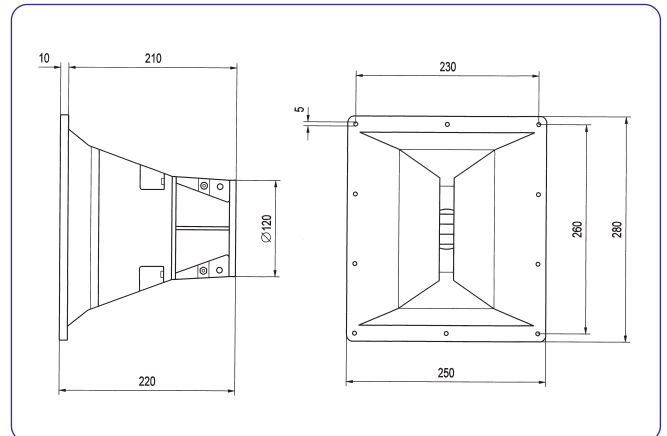

-6dB BEAMWIDTH*

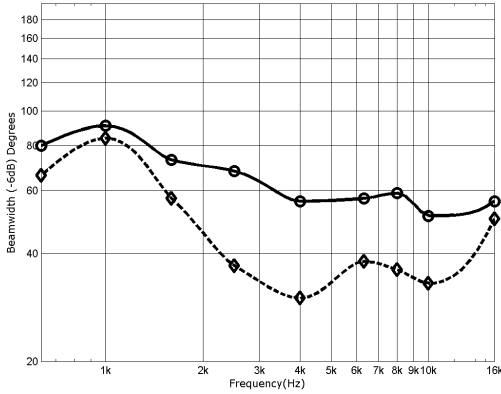

DIRECTIVITY

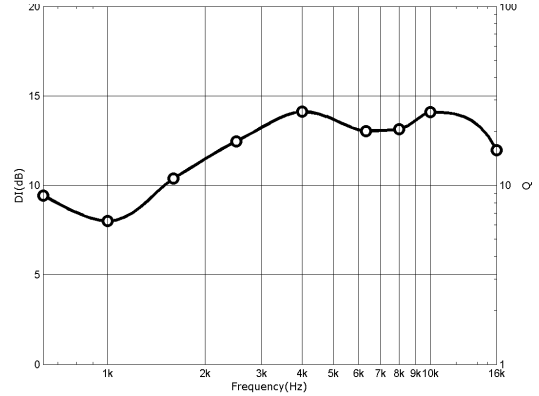

POLAR RESPONSE**

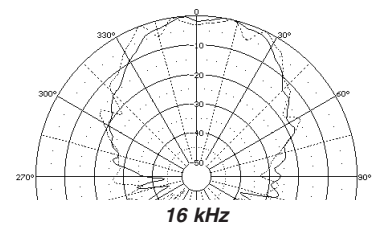
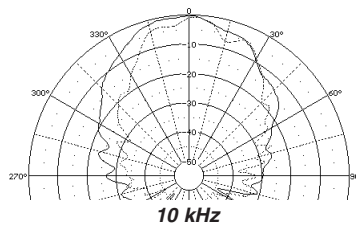
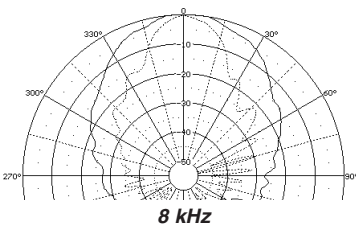
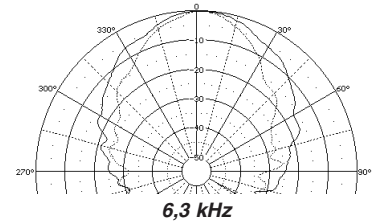
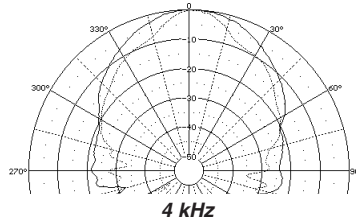
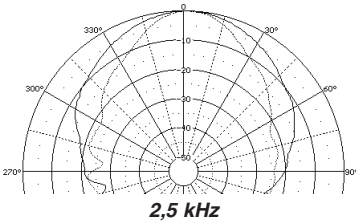
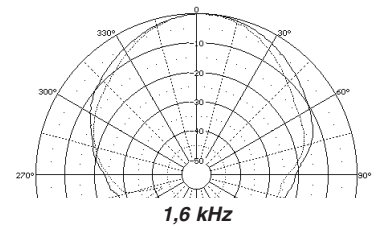
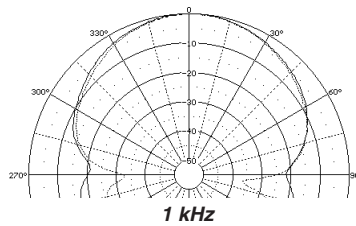
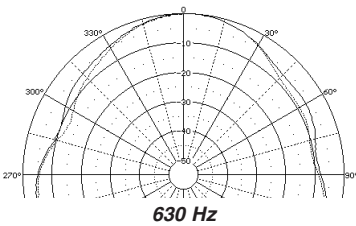

NOTES.

* Horizontal beamwidth is represented by the heavy line. Vertical beamwidth is represented by the discontinuous line.

** Horizontal response is represented by the heavy lines. Vertical response is represented by the discontinuous lines. The polar plots are reproduction of measurements done with single sinusoidal signal tones, at the indicated frequencies. The microphone was placed 2 m from the horn, and rotation was about the centre of the emitter source.



acústica beyma, s.a.