

KEY FEATURES

- Ultra light loudspeaker (2.35 kg. 5.17 lb.)
- High power handling (250 w AES)
- 2.5" (62.4 mm.) aluminium voice coil
- High sensitivity: 95 dB
- Superior performance neodymium magnet system
- Half the weight than a conventional ferrite model
- Large Xmax: 4.5 mm.
- Extra vented magnetic structure
- Designed for extremely compact woofer applications



GENERAL DESCRIPTION

This 8" bass loudspeaker has been designed to achieve a very light loudspeaker with superior technical specifications. Thus, the magnetic system incorporates a high energy neodymium magnet, reducing the total mass of the unit to less than 50% of a conventional ferrite model. Moreover, the heat dissipation has been improved with the use of extra-cooling. The 8LW30 incorporates a 2.5" voice coil made with high quality materials: aluminium wire with high temperature bonding strength and fiber glass former. The 8LW30 is highly recommended for those woofer applications that require a light and small loudspeaker with excellent technical specifications.

FREQUENCY RESPONSE AND DISTORTION CURVES

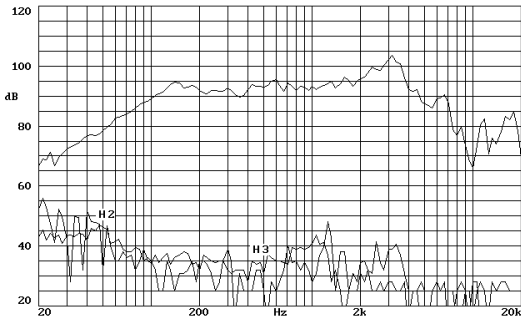

Note: on axis frequency response measured with loudspeaker standing on infinite baffle in anechoic chamber, 1w @ 1m.

FREE AIR IMPEDANCE CURVE

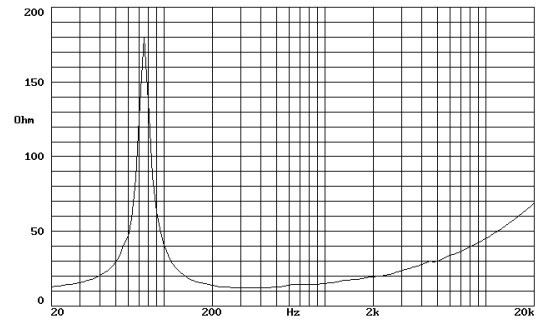

PREDICTED LOW FREQUENCY RESPONSE

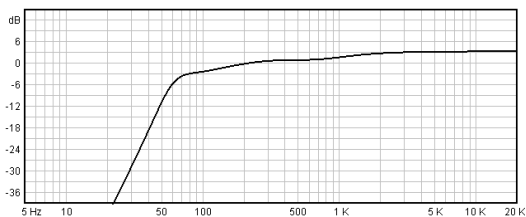

Note: Bass-reflex cabinet, Vb=20 l, fb=65 Hz

POWER COMPRESSION LOSSES

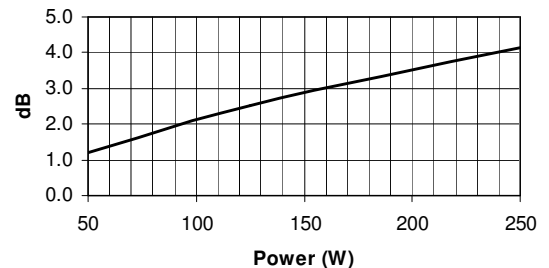

Note: These losses are calculated from a five minutes AES power test applying band limited pink noise (25-1200 Hz). The loudspeaker is free-air standing.

TECHNICAL SPECIFICATIONS

Nominal diameter	200 mm. 8 in.
Rated impedance	8 ohms.
Minimum impedance	6.9 ohms.
Power capacity *	250 w AES
Program power	500 w
Sensitivity	95 dB 2.83v @ 1m @ 2π
Frequency range	65 - 6000 Hz
Recom. enclosure vol.	10 / 30 l 0.35 / 1.06 ft. ³
Voice coil diameter	62.4 mm. 2.5 in.
Magnetic assembly weight	2 kg. 4.4 lb.
BL factor	12 N / A
Moving mass	0.022 kg.
Voice coil length	16 mm.
Air gap height	7 mm.
X damage (peak to peak)	23 mm.

MOUNTING INFORMATION

Overall diameter	212 mm. 8.35 in.
Bolt circle diameter	198 mm. 7.8 in.
Baffle cutout diameter:	
- Front mount	181 mm. 7.12 in.
- Rear mount	181 mm. 7.12 in.
Depth	96 mm. 3.78 in.
Volume displaced by driver	1.5 l 0.056 ft. ³
Net weight	2.35 kg. 5.17 lb.
Shipping weight	2.5 kg. 5.5 lb.

THIELE-SMALL PARAMETERS **

Resonant frequency, fs	70 Hz
D.C. Voice coil resistance, Re	5.8 ohms.
Mechanical Quality Factor, Qms	7
Electrical Quality Factor, Qes	0.39
Total Quality Factor, Qts	0.37
Equivalent Air Volume to Cms, Vas	16 l
Mechanical Compliance, Cms	232 μm / N
Mechanical Resistance, Rms	1.4 kg / s
Efficiency, ηo (%)	1.35
Effective Surface Area, Sd (m ²)	0.0220 m ²
Maximum Displacement, Xmax	4.5 mm
Displacement Volume, Vd	99 cm. ³
Voice Coil Inductance, Le @ 1 kHz	1.1 mH

DIMENSION DRAWINGS

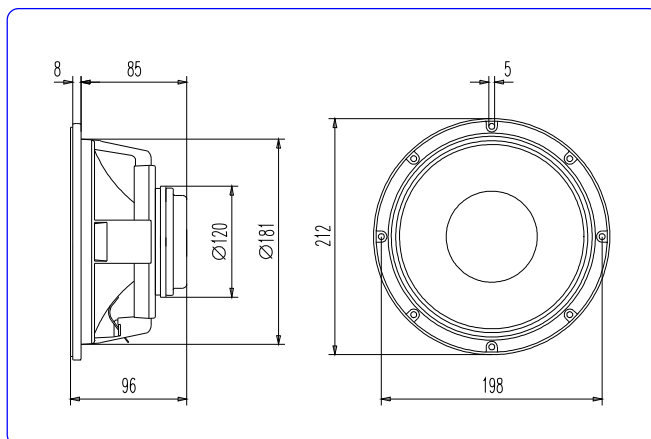

MATERIALS

- **Voice coil:** Round aluminium wire with high temperature bonding strength. Polyimide fiber glass former able to withstand high temperatures.
- **Cone:** high stiffness paper cone.
- **Surround:** treated cloth to guarantee good retaining of elasticity in despite of continuing use.
- **Spider:** cotton spider.
- **Metal parts:** anti-corrosion coated to resist aggressive environmental conditions.
- **Basket:** specially designed die cast aluminium basket to avoid disturbing resonances.
- **Magnet:** high energy neodymium magnet.

Notes:

*The power capacity is determined according to AES2-1984 (r2003) standard. Program power is defined as the transducer's ability to handle normal music program material.

**T-S parameters are measured after an exercise period using a preconditioning power test. The measurements are carried out with a velocity-current laser transducer and will reflect the long term parameters (once the loudspeaker has been working for a short period of time).



acústica beyma, s.a.